

**THE BARTOL MAG-PROBE**

(Read carefully before using.)

**CAUTION:** Damage may result if the "Mag-Probe" is dropped

# Mag-Probe®

**Standard Sensitivity Model "S" and High Sensitivity Model "HS"**

**OPERATING INSTRUCTIONS**  
for  
**THE BARTOL "MAG-PROBE" INSTRUMENT**  
**FOR SENSING MAGNETIC FIELDS**

**CAUTION:** Damage may result if the "Mag-Probe" is dropped.

**GENERAL APPLICATIONS**

ALL VOLTAGES (AC & DC)

SOLENOIDS, SOLENOID VALVES, RELAYS, REED RELAYS, COILS  
ROTARY SOLENOIDS, STEPPER SWITCHES, DETECTING  
RESIDUAL MAGNETISM, COILS, TRANSIENT CURRENT PULSES,  
IDENTIFYING NORTH & SOUTH POLES, ETC.

**SPECIFICATIONS**

RESPONSE TIME – .01 SECOND

SENSITIVITY – VARIABLE

STANDARD MODEL "S" – SENSITIVITY 3 GAUSS  
(TESTS FROM SUB-MINIATURE TO THE LARGEST  
SOLENOID VALVES AND RELAYS)

HIGH SENSITIVITY MODEL "HS" – SENSITIVITY 1 GAUSS  
(TESTS FROM SUB-MINIATURE AND SMALLER TO THE  
LARGEST SOLENOID VALVES AND RELAYS)

OPERATING FREQUENCY – DC TO 400 HZ  
SHELF LIFE – RETAINS 90% OF IT'S OPERATING CAPACITY  
AFTER 3 YEARS  
OPERATING LIFE – 5000 FIVE SECOND TESTS.  
SALT & MOISTURE PROOF  
TEMP RANGE (-40°F TO +160°F)

**THE WHITE MAGNETIC SHIELD**

ON THE "MAG-PROBE'S" TIP REDUCES THE CHANCE OF  
MAGNETIC FIELDS TURNING IT ON DURING STORAGE AND MUST  
BE REMOVED BEFORE USING. **REPLACE THE MAGNETIC SHIELD**  
**AFTER USING.**

**DO NOT STORE THE "MAG-PROBE" NEAR A**  
**PERMANENT MAGNET OR MAGNETIC FIELD.**

A "MAG-PROBE" WILL NOT DETECT DEVICES ENCLOSED  
IN A MAGNETIC SHIELD. (MOST DEVICES AREN'T SHIELDED.)

YOU MAY SELF TEST THE "MAG-PROBE" WITH THE  
HIGH/LOW SENSITIVITY RING SUPPLIED WITH EACH UNIT.

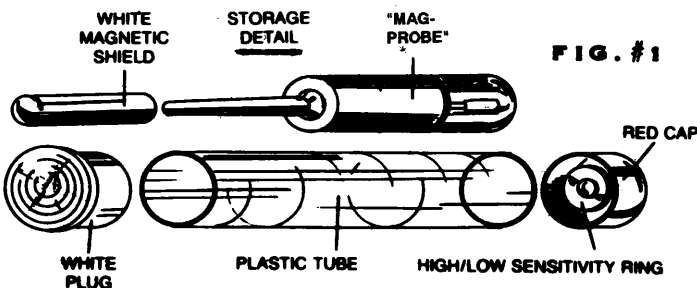

**TESTING AC & DC DEVICES WITHOUT  
USING THE HIGH/LOW SENSITIVITY RING**

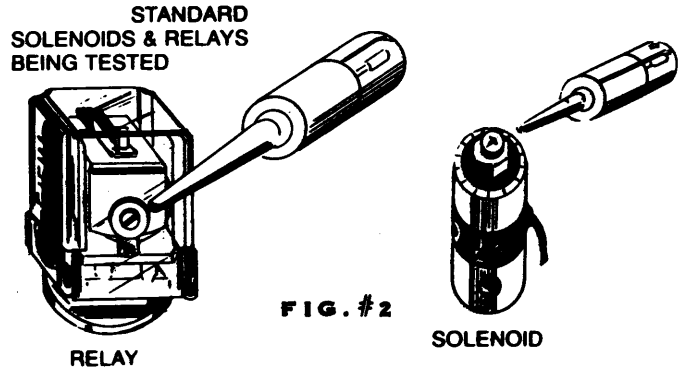

1. HOLD THE "MAG-PROBE" AS SHOWN IN FIGURE 2
2. PLACE THE TIP CLOSE TO OR ON THE SHAFT THAT PROJECTS THROUGH THE DEVICE'S COIL.
3. OBSERVE THE LED IN THE "MAG-PROBE'S" HANDLE.
4. IF THE LED IS ON, THE SOLENOID OR RELAY IS ENERGIZED.
5. IF THE LED IS OFF, THE SOLENOID OR RELAY IS DE-ENERGIZED.
6. IF THE LED TURNS ON AND OFF, AND FLOW THROUGH THE SOLENOID VALVE UNDER TEST IS NOT INTERRUPTED OR POWER THROUGH A RELAY'S CONTACTS DON'T TURN ON AND OFF, A MECHANICAL FAILURE HAS OCCURRED.
7. IF THE LED REMAINS OFF DURING MACHINE OPERATION, TWO POSSIBLE PROBLEMS EXIST:
  - A. NO POWER TO THE SOLENOID OR RELAY.
  - B. AN OPEN COIL.
 TO LOCATE THE PROBLEM, FIRST TEST THE POWER SOURCE, THEN THE SOLENOID OR RELAY COIL.
8. IF TRANSIT PULSES ARE SUSPECTED, HOLD THE PROBE TIP CLOSE TO OR ON THE SOLENOID OR RELAY AND OBSERVE THE LED DURING A MACHINE CYCLE, IF TRANSIT PULSES ARE PRESENT DURING THE TIME THE SOLENOID OR RELAY SHOULD BE OFF, THE LED WILL FLASH ON AND OFF.

WITH A LITTLE PRACTICE, YOU'LL KNOW WHEN TO USE THE HIGH/LOW SENSITIVITY RING IN ORDER TO TEST SUB-MINIATURE AND SMALLER DEVICES.

IF YOU NEED THE ADDED SENSITIVITY, INSTALL THE HIGH/LOW SENSITIVITY RING ACCORDING TO THE FOLLOWING INSTRUCTIONS.

## INSTALLING THE HIGH/LOW SENSITIVITY RING

(SEE FIGURE 3)

NOTE - WHEN TESTING EXTREMELY SMALL MAGNETIC FIELDS SUCH AS SUB-MINIATURE SOLENOIDS AND RELAYS, THE HIGH SENSITIVITY RING MUST BE USED. 1.) HOLD THE HIGH SENSITIVITY RING BETWEEN THE INDEX FINGER AND THUMB WITH THE WHITE DOT ON THE RING TOWARD THE PALM OF YOUR LEFT HAND.

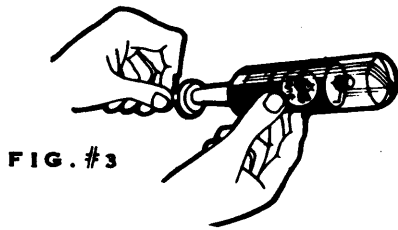

2.) SLIDE THE RING ONTO THE TIP TOWARD THE BODY OF THE MAG-PROBE UNTIL THE RED LED GOES OUT THE FIRST TIME. (SEE FIGURE NO. 4)

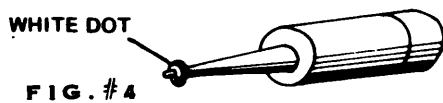

3.) CONTINUE SLIDING THE RING TOWARD THE MAG-PROBE BODY UNTIL THE LED TURNS ON AND THEN OFF FOR THE SECOND TIME. (SEE FIGURE 5) NOW THE MAG-PROBE IS ADJUSTED FOR HIGH SENSITIVITY. TO BE SURE YOU HAVE THE HIGHEST SENSITIVITY OBTAINABLE. SLIDE THE RING BACK UNTIL THE LIGHT IMMEDIATELY TURNS ON. THEN WITH THE TIP OF THE INDEX FINGER AND THUMB PRESSED AGAINST THE RING (FIGURE 3). USE A SLIGHT PINCHING MOTION TO MOVE THE RING TOWARD THE BODY OF THE MAG-PROBE. RELEASE IMMEDIATELY AS SOON AS THE LED TURNS OFF. REMEMBER, FIGURE 5 IS THE CORRECT POSITION.



NOTE: ANY MOVEMENT OF THE RING AFTER THE LED GOES OUT WILL DECREASE THE SENSITIVITY.

### CAUTION:

TO AVOID FALSE INDICATIONS WHEN USING THE HIGH SENSITIVITY RING, THE RING MUST NOT TOUCH A METAL SURFACE, BUT YOU MAY TOUCH A METAL SURFACE WITH THE MAG-PROBE'S TIP.

### REMEMBER:

FIRST TRY YOUR MAG-PROBE WITHOUT THE HIGH SENSITIVITY RING. THEN IF YOU NEED THE HIGH SENSITIVITY TO DETECT THE DEVICE UNDER TEST, SLIP ON THE RING.

YOU'LL SEE ONLY A SMALL DIFFERENCE IN SENSITIVITY BETWEEN THE MODEL "S" AND MODEL "HS" IF YOU DON'T USE THE HIGH/LOW SENSITIVITY RING.

THE MODEL "HS" MUST MEET A MINIMUM SENSITIVITY TEST. APPROXIMATELY TWICE THAT OF THE MODEL "S" WITH THE HIGH/LOW SENSITIVITY RING ATTACHED.

## TESTING AC POWERED DEVICES WITH THE HIGH/LOW SENSITIVITY RING INSTALLED

YOU WON'T HAVE ANY PROBLEMS TESTING ANY AC POWERED DEVICE REGARDLESS OF WHICH END OR SIDE YOU TEST JUST AS LONG AS THE FIELD STRENGTH IS WITHIN THE "MAG-PROBE'S" SENSITIVITY RANGE.

## TESTING DC POWERED DEVICES WITH THE HIGH/LOW SENSITIVITY RING INSTALLED

WHEN USING THE HIGH/LOW SENSITIVITY RING, THE "MAG-PROBE" BECOMES SENSITIVE TO NORTH AND SOUTH POLES. WHITE DOT TOWARD THE "MAG-PROBE'S" TIP, NORTH AND WHEN THE RING IS REMOVED AND INSTALLED WITH THE WHITE DOT ON THE RING TOWARDS THE "MAG-PROBE'S" LED, YOU'LL DETECT ONLY SOUTH POLES.

DC POWERED DEVICES CAN BE CONNECTED TO A POWER SOURCE 2 WAYS. (SEE FIGURE 6A & 6B.)

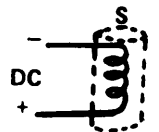
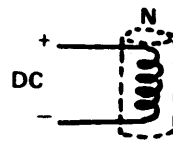

IN FIGURE 6A, ASSUME THAT A NORTH POLE OCCURS AT THE COIL'S UPPER END WHEN A DC VOLTAGE IS APPLIED AS SHOWN. IF THE POLARITY OF THE APPLIED VOLTAGE IS REVERSED AS SHOWN IN FIGURE 6B, A SOUTH POLE IS GENERATED AT THE UPPER END. TRY BOTH ENDS OF AN OPERATING SOLENOID, RELAY, REED RELAY, OR DC DEVICE. ONCE YOU ESTABLISH WHICH END OF THE RELAY OR DC DEVICE CAUSES THE "MAG-PROBE" TO OPERATE, THE OTHER RELAYS OR DC DEVICES INSTALLED IN THE INSTRUMENT UNDER TEST SHOULD RESPOND AT THE SAME END. SEE FIGURE 7

PHOTO SHOWING TESTS ON BOTH ENDS OF A DC SOLENOID

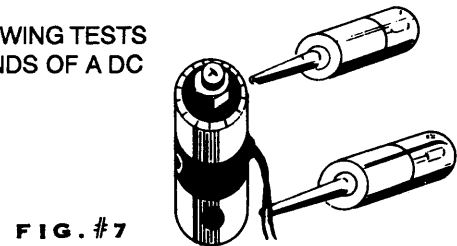

## TESTING REED RELAYS MODEL "HS" ONLY

SINCE REED RELAYS ARE DC POWERED, YOU MUST FOLLOW THE ABOVE INSTRUCTIONS FOR TESTING DC POWERED DEVICES.

IF A REED RELAY IS MOUNTED IN SUCH A WAY THAT YOU ARE UNABLE TO REACH THE NORMALLY TESTED END, REVERSE THE HIGH/LOW SENSITIVITY RING AND TEST THE ACCESSIBLE END (OPPOSITE). SEE FIGURE 8

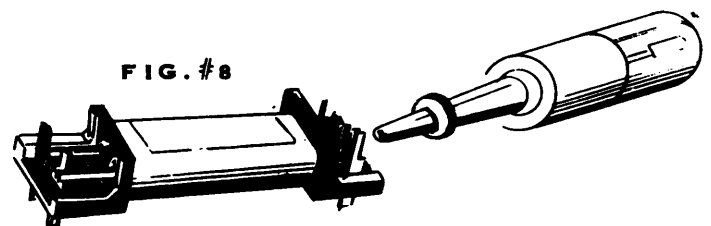

# AUTOMOTIVE OPERATING INSTRUCTIONS

## for THE BARTOL "MAG-PROBE" (Read carefully before using.)

## Standard Sensitivity Model "S" and High Sensitivity Model "HS"

**CAUTION: Damage may result if the "MAG-PROBE" is dropped**

### AUTOMOTIVE APPLICATIONS

ALTERNATORS, VOLTAGE REGULATORS, SOLENOIDS, RELAYS, ELECTRONIC IGNITION SYSTEMS, MAGNETIC CLUTCHES, STANDARD IGNITION SYSTEMS, FUEL INJECTOR RELAYS & ELECTRONIC FUEL PUMPS.

A "MAG-PROBE" ISN'T THE LAST WORD IN ALTERNATOR, VOLTAGE REGULATOR, AND IGNITION TROUBLE SHOOTING, BUT IT DOESN'T COST SEVERAL HUNDRED DOLLARS EITHER.

A "MAG-PROBE" IS AN EFFECTIVE INSTRUMENT USED TO LOCATE MOST COMMON PROBLEMS WITHOUT HAVING ANY KNOWLEDGE OF ELECTRICITY.

IF YOU HAVE SOME AUTOMOTIVE OR ELECTRICAL TRAINING YOU'LL PROBABLY FIND MORE APPLICATIONS FOR THE "MAG-PROBE".

### TROUBLE SHOOTING

FIRST, CHECK THE BATTERY. CAUTION: (WEAR SAFETY GLASSES OR A FACE SHIELD WHEN WORKING AROUND THE BATTERY.) YOU SHOULD HAVE A FULLY CHARGED BATTERY BEFORE TESTING THE CHARGING SYSTEM. IF YOU DON'T HAVE THE EQUIPMENT TO FULLY CHARGE AND TEST YOUR BATTERY, HAVE IT CHARGED AND TESTED AT THE STORE WHERE IT WAS PURCHASED. MOST STORES WILL TEST IT FREE AND CHARGE IT FOR A SMALL FEE. EVEN IF YOU CHARGE IT OVER NIGHT WITH A TRICKLE CHARGER, YOUR BATTERY STILL COULD HAVE A BAD CELL. P.S. CHECK THE BATTERY WATER & SPECIFIC GRAVITY OF EACH CELL.

CHECK THE BATTERY CABLES!!! CLEAN THE BATTERY POSTS AND CABLE ENDS WITH A BAKING SODA AND WATER SOLUTION. (ABOUT 1 TSP PER GLASS OF WATER). THEN CLEAN THE BATTERY CABLE ENDS AND BATTERY POSTS WITH A WIRE BRUSH. YOU CAN PURCHASE ONE AT MOST AUTOMOTIVE STORES.

WATCH OUT FOR BATTERY END CABLE REPLACEMENTS. THESE ARE USED TO REPLACE THE CABLE END THAT ATTACHES TO THE BATTERY POST. THESE CABLE ENDS USUALLY CAUSE PROBLEMS DUE TO OXIDATION. WHEN OXIDATION OCCURS, THE CHARGE RATE WILL BE LOW AND THE STARTER WILL NOT HAVE SUFFICIENT CURRENT TO TURN THE ENGINE AT A NORMAL STARTING SPEED. FOR BEST RESULTS, USE ONE PIECE BATTERY CABLES.

MAKE SURE THE BLACK (NEGATIVE) BATTERY CABLE HAS A GOOD GROUND. A BAD GROUND CAN CAUSE THE SAME PROBLEM AS A BAD BATTERY CABLE.

YOU'VE ALREADY MADE SURE THE END THAT ATTACHES TO THE BATTERY IS GOOD, SO CHECK THE OPPOSITE END THAT ATTACHES TO THE CARS' FRAME. REMOVE THE BOLT THAT ATTACHES THE BATTERY CABLE TO THE CARS' FRAME THEN CLEAN THE CABLE END AND METAL SURFACE AROUND THE BOLT HOLE. BOLT THE CABLE FIRMLY TO THE FRAME.

CHECK THE FAN BELT. A HARD DRIED OUT OR LOOSE BELT WILL SLIP, CAUSING LOW ALTERNATOR OUTPUT. CHECK WITH THE LOCAL DEALER FOR PROPER TIGHTNESS.

CHECK YOUR ALTERNATOR TROUBLE LIGHT AT NIGHT. IF IT WON'T GO COMPLETELY OUT (APPEARS DIM) WITH THE HEADLIGHTS OFF, THE ALTERNATOR BELT COULD BE LOOSE OR DRIED OUT.

### TESTS ALTERNATOR AND REGULATOR

LOCATE THE LARGE WIRE ATTACHED TO THE ALTERNATOR TERMINAL MARKED "BATT". THIS WIRE IS USUALLY RED AND IS CONNECTED TO THE UPPER OR LOWER SECTION OF THE ALTERNATOR. (SEE FIGURE A-1)

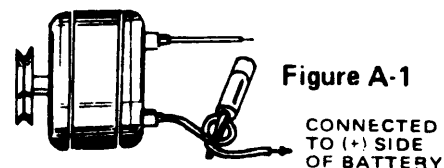

Figure A-1

CONNECTED TO (+) SIDE OF BATTERY

IF YOU HAVE TROUBLE LOCATING THIS WIRE, THEN FOLLOW THE RED BATTERY CABLE FROM THE POSITIVE BATTERY POST TO THE OPPOSITE END FROM THE BATTERY. THE ALTERNATOR WIRE SHOULD BE CONNECTED TO THIS POINT. THIS WIRE MUST BE CONNECTED BEFORE THE ALTERNATOR CAN CHARGE THE BATTERY.

NOW MAKE A LOOP IN THE ALTERNATOR WIRE BY TWISTING THE WIRE ONCE. (SEE FIGURE A-1) THIS LOOP MUST BE AT LEAST 6 INCHES AWAY FROM THE ALTERNATOR TO PREVENT DETECTING THE ALTERNATOR'S MAGNETIC FIELD. THE LOOP SHOULD BE ONLY LARGE ENOUGH FOR THE "MAG-PROBE'S" TIP TO SNUGLY FIT.

### TEST NO. 1

DO THIS TEST WITH THE ENGINE OFF. INSTALL THE HIGH/LOW RING (FIG. 3) OF THE GENERAL INSTRUCTIONS.

INSERT THE "MAG-PROBE'S" TIP INTO THE TEST LOOP FROM ONE DIRECTION, THEN THE OTHER.

IF THE LED LIGHTS, THE ALTERNATOR HAS A SHORT TO GROUND AND SHOULD BE REPLACED.

REMOVE THE HIGH/LOW RING, AND STORE IT IN THE TUBE. REPLACE THE METAL SHIELD ON THE "MAG-PROBE".

START THE ENGINE AND INCREASE ENGINE SPEED TO A FAST IDLE.

CAUTION: DURING THIS TEST, KEEP YOUR HANDS CLEAR OF ALL MOVING PARTS IN THE ENGINE COMPARTMENT, I.E.. FAN BLADE, FAN BELT, ETC.

### TEST NO. 2

TURN ON THE HEADLIGHTS, AND ALL THE ACCESSORIES.

REMOVE THE "MAG-PROBE'S" SHIELD.

NOW HOLD THE "MAG-PROBE" CLOSE TO THE ALTERNATOR, SEE FIGURE A-2. USUALLY FROM 1 TO 3 INCHES. SLOWLY MOVE THE "MAG-PROBE" AROUND THE UPPER SECTION OF THE ALTERNATOR. AT SOME POINT THE LED IN THE "MAG-PROBE" SHOULD TURN ON, OR CONTINUE FLASHING ON AND OFF.

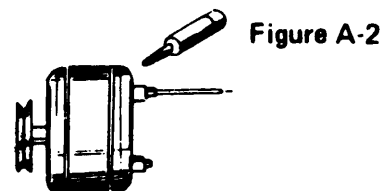

Figure A-2

IF IT DOESN'T LIGHT, THE VOLTAGE REGULATOR IS PROBABLY BAD AND IT SHOULD BE REPLACED. OTHER PROBLEMS CAN CAUSE THIS INDICATION, BUT IT'S USUALLY THE VOLTAGE REGULATOR. NOTE: IF YOU REPLACE THE VOLTAGE REGULATOR, GO BACK TO TEST NO. 2.

### TEST NO. 3

INSERT THE "MAG-PROBE'S" TIP INTO THE LOOP MADE IN TEST NO. 1 AS SHOWN IN FIGURE A-1. THE LIGHT IN THE "MAG-PROBE" SHOULD TURN ON. IF IT DOESN'T, REPLACE THE ALTERNATOR. REMEMBER, THE ENGINE MUST BE RUNNING AT A FAST IDLE DURING THIS TEST, WITH THE HEADLIGHTS ON.

NOW THAT YOU HAVE A LOOP IN THE ALTERNATOR OUTPUT WIRE YOU CAN MAKE A QUICK TEST BY (1) STARTING THE ENGINE (2) TURNING ON THE HEADLIGHTS AND GOING DIRECTLY TO TEST NO. 3.

### TESTING STANDARD IGNITION SYSTEMS

TO FIND OUT IF THE POINTS IN THE DISTRIBUTOR ARE OPERATING (OPENING AND CLOSING), WITHOUT REMOVING THE DISTRIBUTOR CAP -- HOLD THE "MAG-PROBE" ABOUT 4 INCHES AWAY FROM THE COILS' TOP AS ILLUSTRATED IN FIGURE "B".

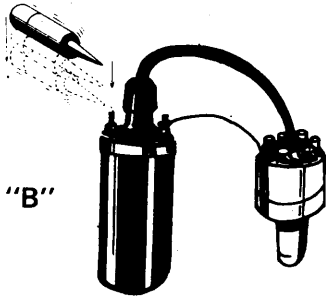

Figure "B"

NOW HAVE SOMEONE TURN ON THE ENGINE'S STARTER AS YOU OBSERVE THE "MAG-PROBE". SLOWLY MOVE THE "MAG-PROBE" IN THE DIRECTION OF THE ARROW (TOWARD THE COIL). AT A POINT NEAR THE COIL, THE LED SHOULD START FLASHING ON AND OFF.

IF THE LED TURNS ON AND STAYS ON AS THE ENGINE CRANKS, THE POINTS ARE STAYING CLOSED. IF THE LED NEVER TURNS ON EVEN WHEN YOU TOUCH THE TOP OF THE COIL, THE POINTS ARE STAYING OPEN OR THE IGNITION SWITCH ISN'T SUPPLYING VOLTAGE TO THE COIL, ABOUT 99% OF THE TIME, FAULTY POINTS ARE THE PROBLEM.

### TESTING ELECTRONIC IGNITION SYSTEMS

LOCATE THE IGNITION COIL. ON SOME GM CARS IT'S MOUNTED ON TOP OF THE DISTRIBUTOR, FIGURE "C".

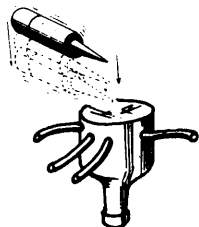

Figure "C".

ON MOST OTHER CARS, FOREIGN INCLUDED, THE COIL IS LOCATED AWAY FROM THE DISTRIBUTOR, FIG. "B". THE CENTER HIGH TENSION WIRE IN THE DISTRIBUTOR WILL BE PLUGGED INTO THE COIL.

TO FIND OUT IF THE ELECTRONIC SYSTEM IS APPLYING CURRENT TO THE COIL, HOLD THE "MAG-PROBE" ABOUT 4 INCHES AWAY FROM THE COIL'S TOP AS ILLUSTRATED IN FIGURE "C". NOW PREFORM TEST "B". IF THE LED TURNS ON AND STAYS ON OR NEVER TURNS ON, THE "ELECTRONIC MODULE" OR "ELECTRONIC

CONTROL UNIT" IS PROBABLY BAD. ABOUT 90% OF THE TIME, THIS IS THE PROBLEM.

ON GM CARS, THE ELECTRONIC MODULE IS LOCATED INSIDE THE DISTRIBUTOR. ON MOST OTHER CARS, THE ELECTRONIC CONTROL UNIT IS MOUNTED OUTSIDE THE DISTRIBUTOR.

IF THE LIGHT FLASHES ON AND OFF AS IT SHOULD IN THE ABOVE PROCEDURE AND THE CAR STILL WON'T START, THEN REMOVE A HIGH TENSION WIRE FROM A SPARK PLUG AND HOLD IT 3/4 INCH FROM THE ENGINE BLOCK AND CRANK THE ENGINE. IF YOU DON'T SEE ANY SPARK OR IT WON'T JUMP AT LEAST 3/4", REMOVE THE DISTRIBUTOR CAP AND CHECK FOR CRACKS OR BLACK LINES (CARBON ARCS) FROM THE CENTER CONTACT DOWN THE SIDES. CHANGE IT IF YOU SEE ANY.

IF THE DISTRIBUTOR CAP LOOKS OKAY, YOU PROBABLY HAVE A BAD COIL.

### TESTING ELECTRONIC IGNITION SYSTEMS

#### HINTS

NO. 1 IF YOUR CAR WON'T START AND IT USES AN ELECTRONIC CONTROL UNIT, PULL THE PLUGS OUT OF THE ELECTRONIC CONTROL UNIT AND GIVE THEM A GOOD CLEANING.

NO. 2 CHRYSLER: CAR WON'T START. WATCH OUT FOR A BAD BALLAST RESISTOR. THIS IS A COMMON PROBLEM. WHEN ONE BURNS OUT, YOU CAN SEE IT BY UNSCREWING IT FROM THE FIREWALL.

FIND OUT WHERE IT'S LOCATED BEFORE YOU HAVE STARTING PROBLEMS. KEEP A SPARE IN YOUR TRUNK.

## 2 MODELS TO CHOOSE FROM

### Standard Sensitivity Model "S"

For testing the largest to standard sized solenoids and relays, suitable for automotive applications, including alternators and voltage regulator tests.

### High Sensitivity Model "HS"

Our most sensitive model. For testing the largest to sub-miniature solenoids, relays and most reed relays and all automotive applications.

## HOW TO ELIMINATE DETECTING OVERLAPPING MAGNETIC FIELDS

THIS CONDITION OCCURS IF TWO OR MORE LARGE SOLENOIDS OR RELAYS ARE CLOSE TOGETHER.

DEPENDING ON HOW YOU USE THE HIGH/LOW SENSITIVITY RING, YOU WILL BE ABLE TO INCREASE OR DECREASE THE "MAG-PROBE'S" SENSITIVITY.

IN THIS CASE, YOU WANT TO REDUCE THE SENSITIVITY JUST ENOUGH TO DETECT ONLY ONE SOLENOID VALVE OR RELAY.

### YOU MUST INSTALL THE HIGH/LOW SENSITIVITY RING

FOLLOW THE DIRECTIONS ON PAGE 2 FIGURES 3, 4 & 5

#### AC DEVICES

NO SPECIAL PRECAUTION IS NECESSARY. THE HIGH/LOW SENSITIVITY RING MAY BE INSTALLED WITH THE WHITE DOT IN EITHER DIRECTION.

#### DC DEVICES

EVEN IF YOU DON'T NEED THE HIGH/LOW RING TO DETECT THE DC DEVICE, YOU MUST INSTALL IT IN ORDER TO REDUCE THE "MAG-PROBE'S" SENSITIVITY.

AFTER INSTALLING THE HIGH/LOW RING, TRY TO DETECT THE LARGE DEVICE WITH THE POWER APPLIED. (SEE "TESTING DC POWERED DEVICES". IT MAY BE NECESSARY TO REVERSE THE HIGH/LOW RING.)

#### AC & DC DEVICES

SLIDE THE HIGH/LOW RING SLIGHTLY IN THE DIRECTION OF THE "MAG-PROBE'S" LED, TRY IT ON THE DEVICE UNDER TEST, FIGURE 2, KEEP SLIDING THE HIGH/LOW RING TOWARD THE "MAG-PROBE'S" LED UNTIL THE "MAG-PROBE'S" TIP ALMOST TOUCHES THE DEVICE UNDER TEST BEFORE THE LED TURNS ON. NOW YOU'LL DETECT ONLY THE DEVICE UNDER TEST. (IF YOU TEST LARGE SOLENOIDS AND RELAYS A MAJORITY OF THE TIME, USE A STANDARD "MAG-PROBE" MODEL "S".

### ESTIMATING HIGH OR LOW VOLTAGES STANDARD SIZED AND LARGER SOLENOIDS AND RELAYS ONLY

(DON'T USE THE HIGH/LOW SENSITIVITY RING). WITH A LITTLE PRACTICE YOU SHOULD BE ABLE TO DETERMINE IF A HIGH OR LOW VOLTAGE CONDITION EXISTS. FOR EXAMPLE: AFTER TESTING A 12 VDC SOLENOID VALVE SEVERAL TIMES, YOU NOTICE THAT THE "MAG-PROBE" LIGHTS AT APPROXIMATELY THE SAME DISTANCE. (TEST THE SAME POINT EACH TIME). THIS IS NORMAL IF THE VOLTAGE IS CONSTANT. HOWEVER, IF THE "MAG-PROBE" LIGHTS AT EITHER A CLOSER OR GREATER DISTANCE FROM THE DEVICE THAN NORMAL, THEN A VOLTAGE CHANGE HAS OCCURRED. AN INCREASE IN VOLTAGE INCREASES THE MAGNETIC FIELD. THUS, A LOW VOLTAGE WOULD DECREASE THE MAGNETIC FIELD. OF COURSE, THERE IS A CHANCE THAT A RESISTANCE CHANGE HAS TAKEN PLACE WITHIN THE DEVICE UNDER TEST, BUT THE ODDS (BY A LONG SHOT) FAVOR A VOLTAGE CHANGE.

### TESTING FOR RESIDUAL MAGNETISM

IF YOU SUSPECT THAT RESIDUAL MAGNETISM IS CAUSING A MALFUNCTION, INSTALL THE HIGH SENSITIVITY RING ON THE "MAG-PROBE" PER INSTRUCTIONS FOR HIGH SENSITIVITY. NEXT, TURN OFF THE POWER TO THE DEVICE UNDER TEST. NOW FOLLOW THE

PROCEDURE FOR TESTING AC & DC DEVICES. FIG 2

IF THE LED TURNS ON, YOU'VE FOUND RESIDUAL A MAGNETIC FIELD.

TO BE DOUBLE SURE, REVERSE THE RING AND TEST AGAIN. (YOU MAY HAVE A SOUTH POLE.)

### HANDY HINTS

IF CONTROL SWITCHES ARE BEYOND ARMS LENGTH, TAPE THE "MAG-PROBE'S" TIP TO THE DEVICE UNDER TEST, OBSERVE THE LED AS YOU CYCLE THE MACHINE. (MASKING TAPE WORKS WELL.)

IF THE DEVICE TO BE TESTED IS LOCATED IN AN ELECTRICALLY HOT AREA, TAPE THE "MAG-PROBE" TO A WOODEN DOWEL OR OTHER NON-CONDUCTIVE MATERIAL. NOW YOU CAN INSERT THE "MAG-PROBE" DEEP INSIDE EQUIPMENT WITHOUT DANGER OF SHOCK. KEEP YOUR HANDS AND ARMS CLEAR OF EXPOSED WIRE.

### REMEMBER:

BEFORE TROUBLE SHOOTING USING THE HIGH/LOW SENSITIVITY RING, PRACTICE ADJUSTING YOUR "MAG-PROBE" FOR MAXIMUM SENSITIVITY. TRY IT ON A SMALL PERMANENT MAGNET. GOOD TROUBLE SHOOTING!

**THE BLACK TUBE.** LOCATED IN THE STORAGE BAG, SLIPS OVER THE RED CAP AND SHIELDS THE LED FROM BRIGHT SUNLIGHT OR BRIGHT INDOOR LIGHTS.

**WWW.MAG-PROBE.COM**

*Manufactured in The United States of America*

THE FOLLOWING:

### SPECIAL APPLICATION NOTE

#### ALTERNATOR & GENERATOR OUTPUT CURRENT LEVEL TEST

WAS WRITTEN FOR THE MOST TECHNICALLY QUALIFIED USERS ONLY. WE'VE INCLUDED IT AS A BONUS, BUT DON'T GUARANTEE POSITIVE RESULTS FOR ALL PERSONS.